

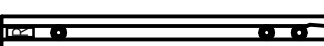











Wand

- 1.1 1xL 
- 1.2 1xR 
- 2.1 1xL  2.2 1xR 
- 3 2 x 
- 4 2 x  10x4x0,8 mm
- 5 2 x  M7x4 mm
- 6 2 x  M4x5 mm
- 7 2 x  M4x10 mm
- 8 2 x  ϕ 4x40 mm
- 9 2 x  ϕ 5x50 mm
- 10 2 x  ϕ 6x30 mm
- 11 2 x  ϕ 8x40 mm
- 12 1 x  SW 2,5



2

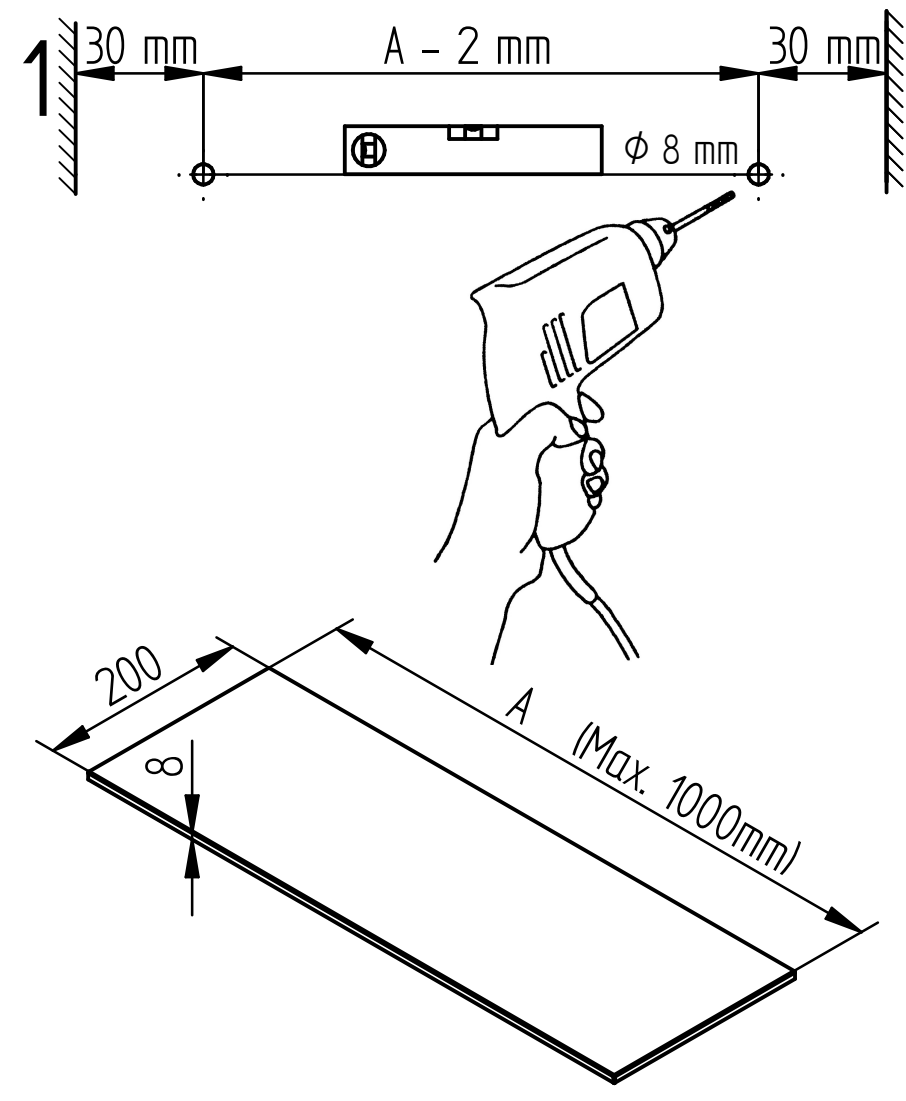
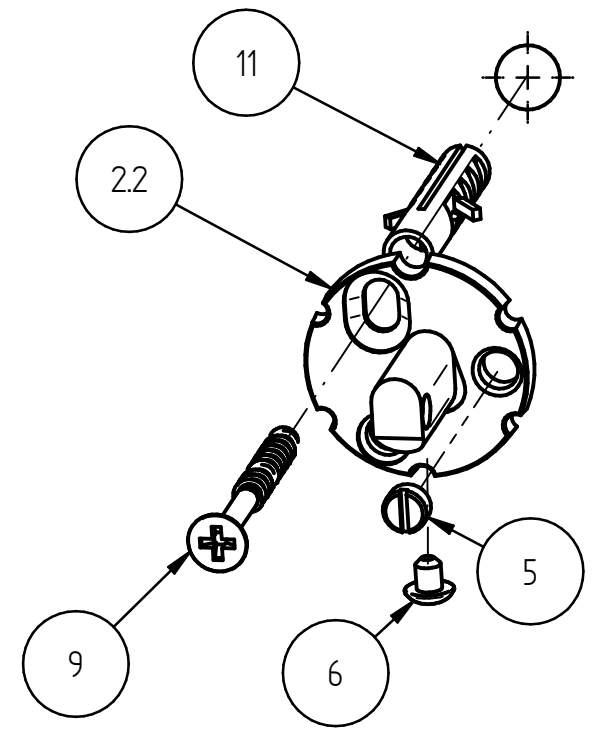
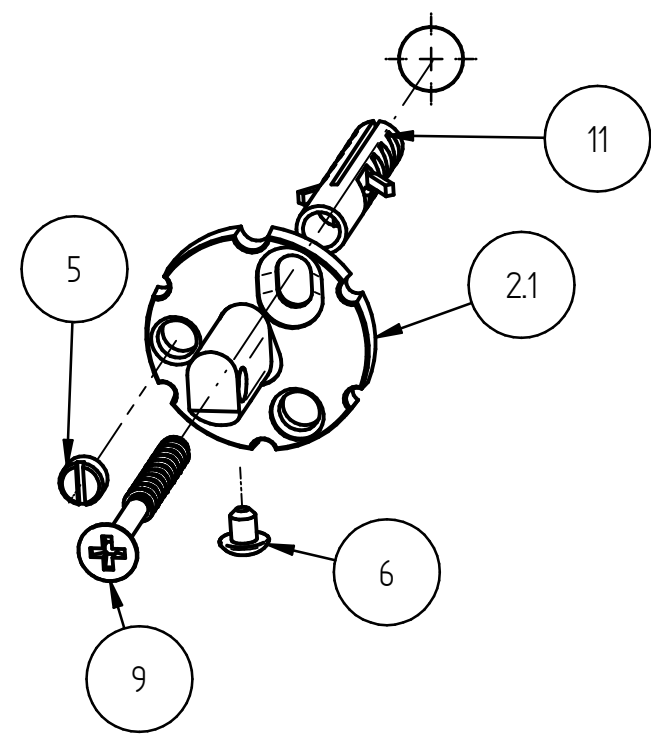



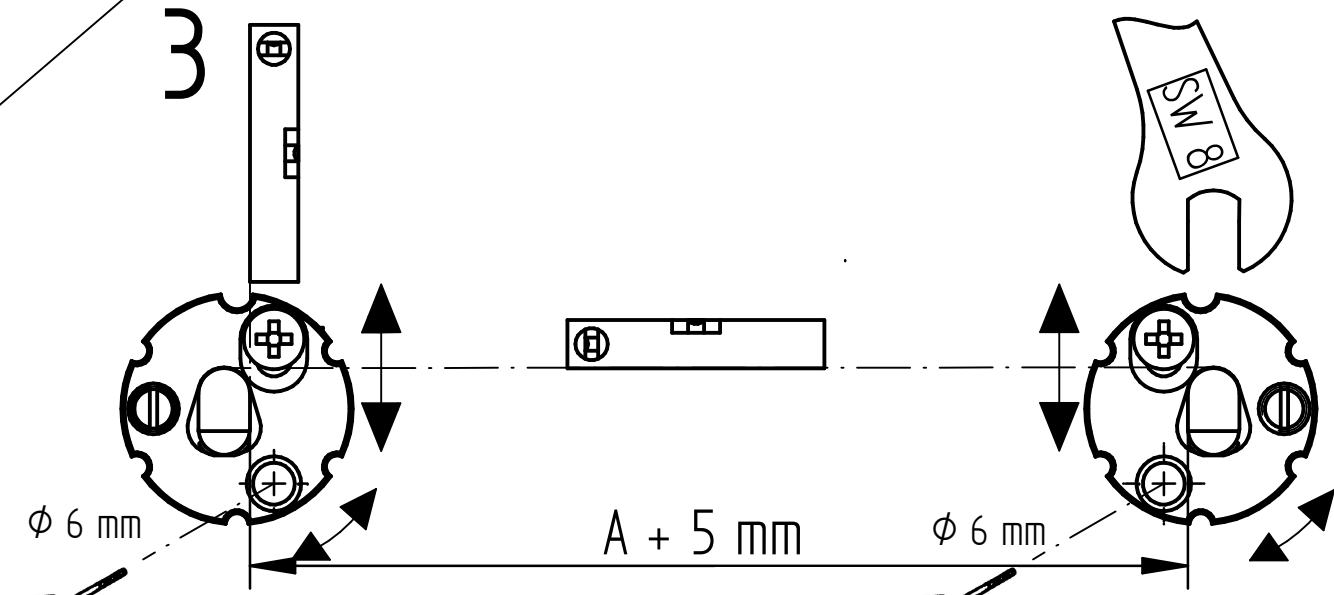



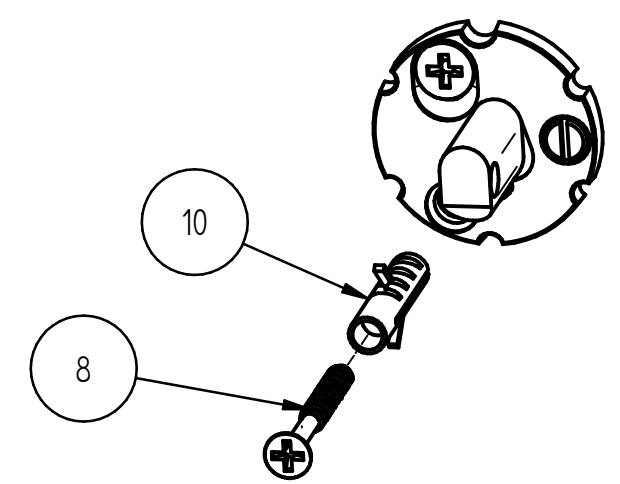
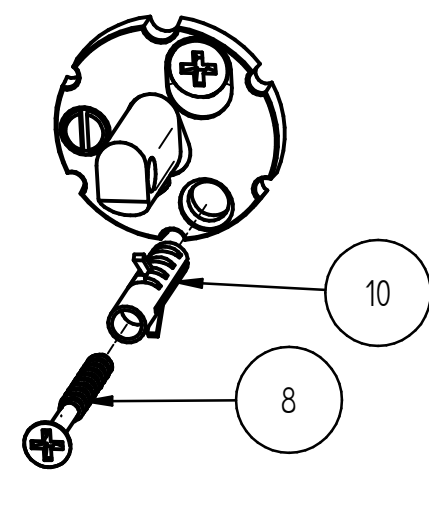







3



4



Wand

- 1.1 1xL 
- 1.2 1xR 
- 2.1 1xL  2.2 1xR 
- 3 2 x 
- 4 2 x  10x4x0,8 mm
- 5 2 x  M7x4 mm
- 6 2 x  M4x5 mm
- 7 2 x  M4x10 mm
- 8 2 x  ϕ 4x40 mm
- 9 2 x  ϕ 5x50 mm
- 10 2 x  ϕ 6x30 mm
- 11 2 x  ϕ 8x40 mm
- 12 1 x  SW 2,5

